

雅2004以降、雅V16 伸縮部材追加一覽

250 墓誌 / 00 墓誌

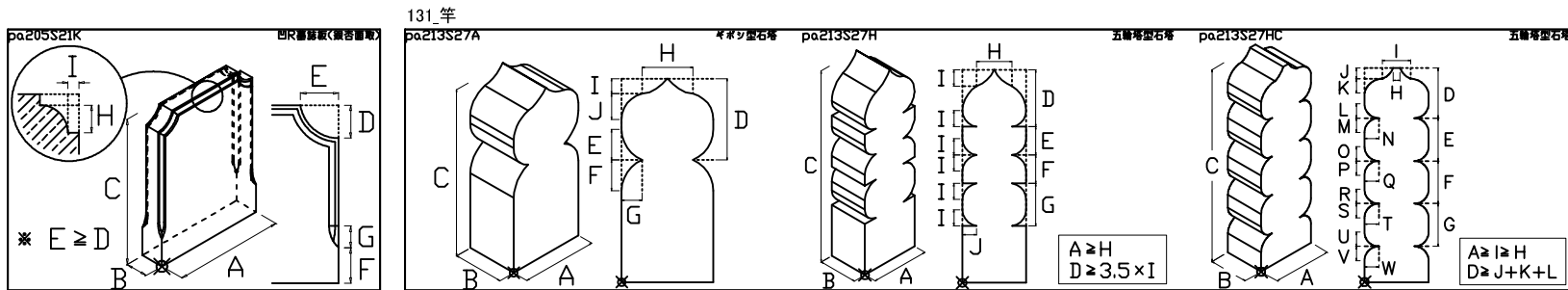

280 抜き型 / 05 水抜・模様・その他

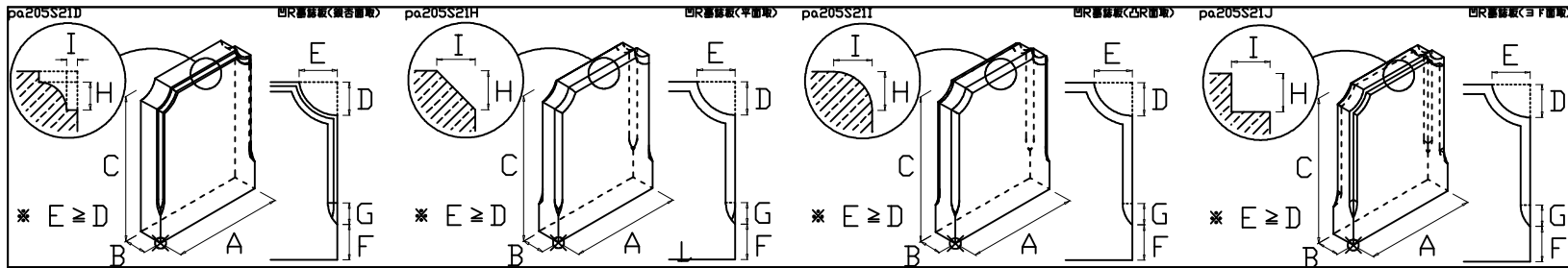
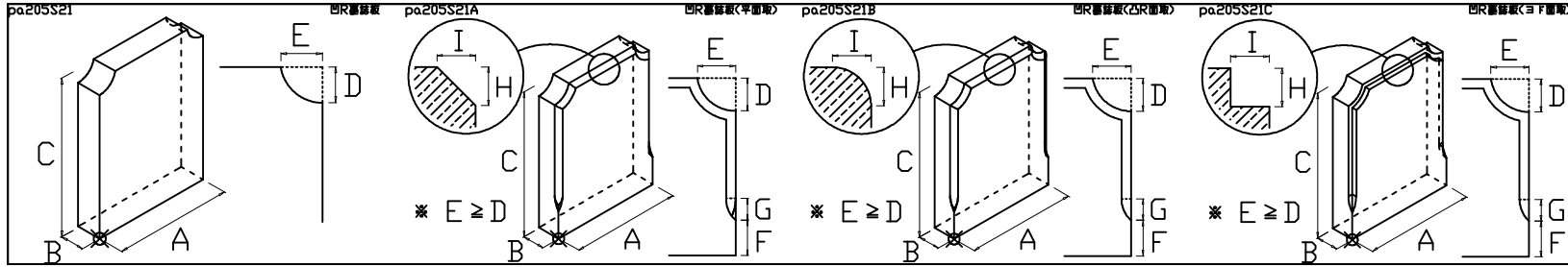
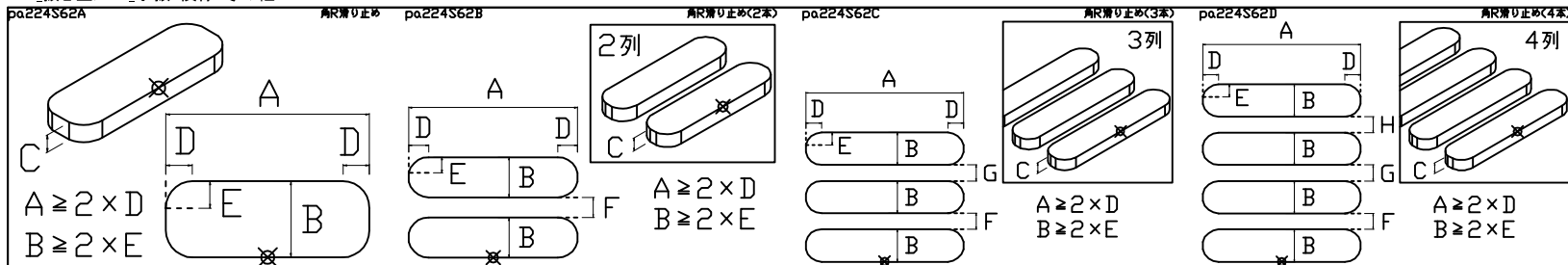

136. 水鉢

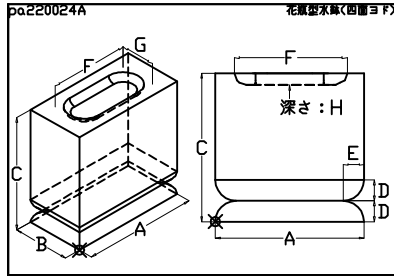

137. 香炉

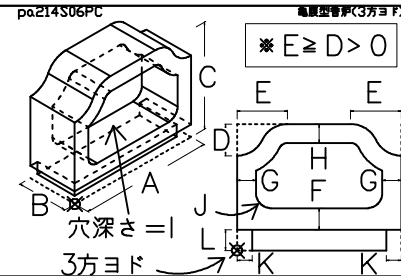
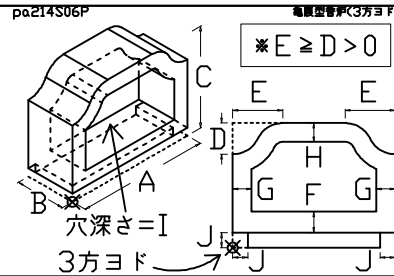
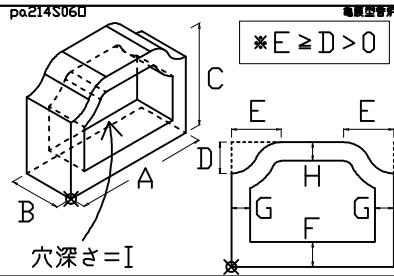
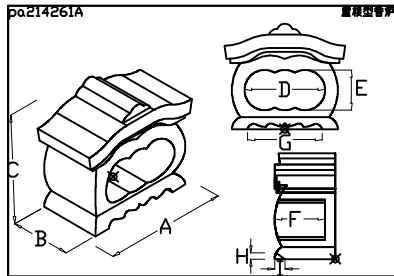
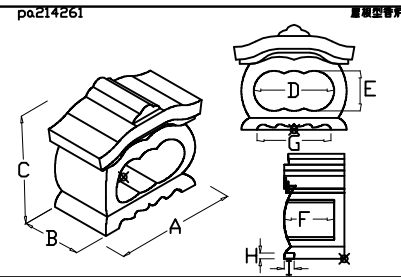
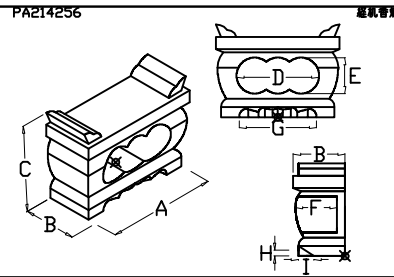
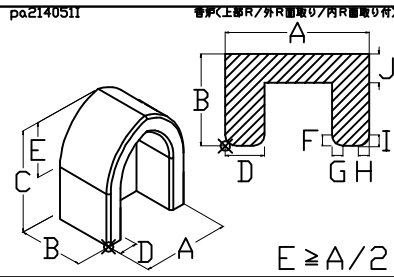
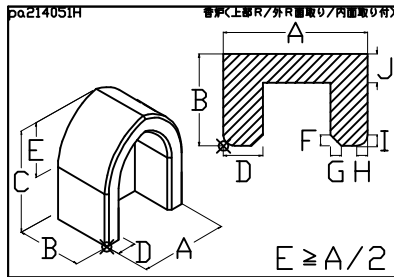
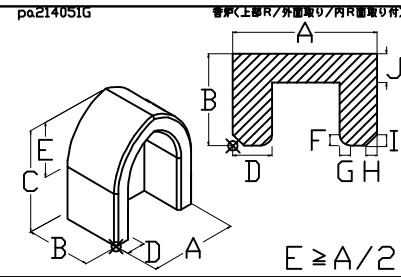
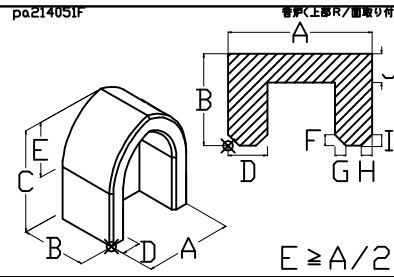
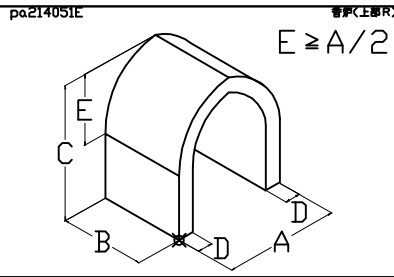
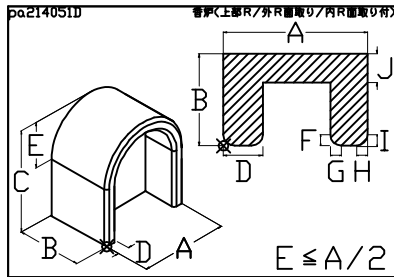
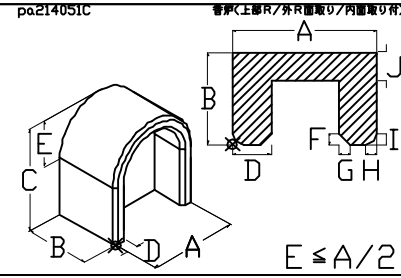
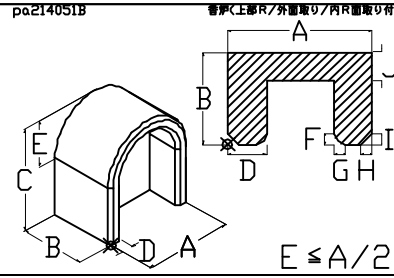
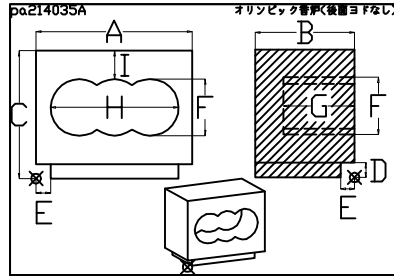

135_花立

pa214064A

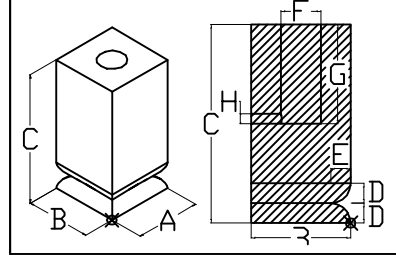

005_階段/00_階段

pa204S02LH

正付スロープ階段<1本置>

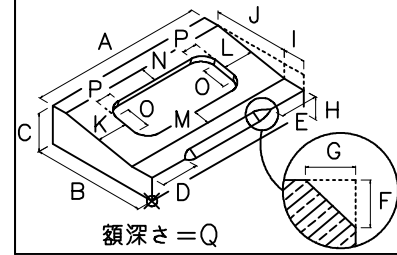

pa204S02LI

正付スロープ階段<2本置>

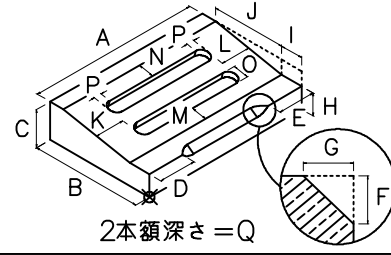

pa204S02LJ

正付スロープ階段<3本置>

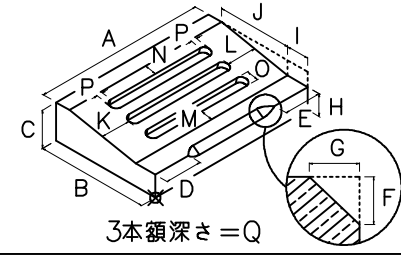

000_外柵/02_腰石・巻石

pa212SS4H

※入外欄

